

1041-16

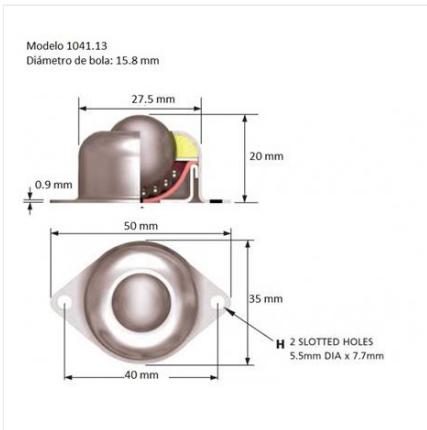

Especificaciones

Material	Acero galvanizado
Material del balín	Acero inoxidable
Diámetro	15.8 mm
Marca	Alwayse
Capacidad de carga	20 kg
Tipo de montaje	Placa
Peso	0.042 kg