

1503-14

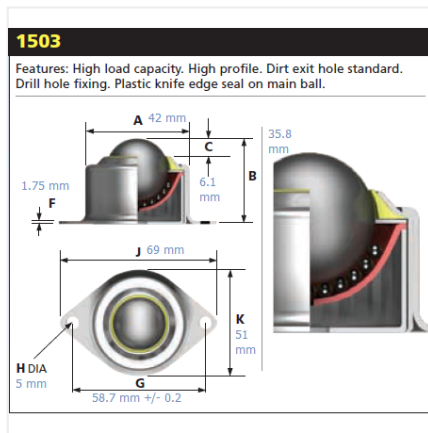

Especificaciones

Material	Acero galvanizado
Material del balín	Nylon
Diámetro	25.4 mm
Marca	Alwayse
Capacidad de carga	25 kg
Tipo de montaje	Placa
Peso	0.2 kg