

# 1702-15

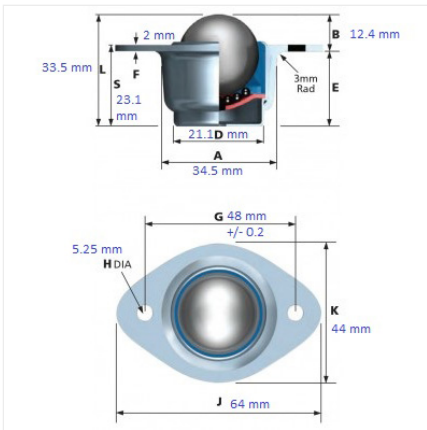

## Especificaciones

Material	Acero inoxidable
Material del balín	Acero inoxidable
Diámetro	25.4 mm
Marca	Alwayse
Capacidad de carga	50 kg
Tipo de montaje	Brida
Peso	0.12 kg