

1703-16

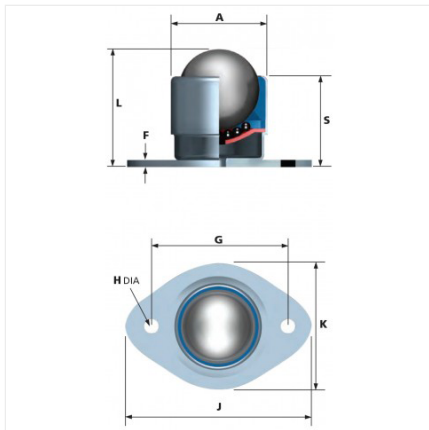

Especificaciones

Material	Acero galvanizado
Material del balín	Acero inoxidable
Diámetro	25.4 mm
Marca	Alwayse
Capacidad de carga	50 kg
Tipo de montaje	Placa
Peso	0.12 kg