

2009-16

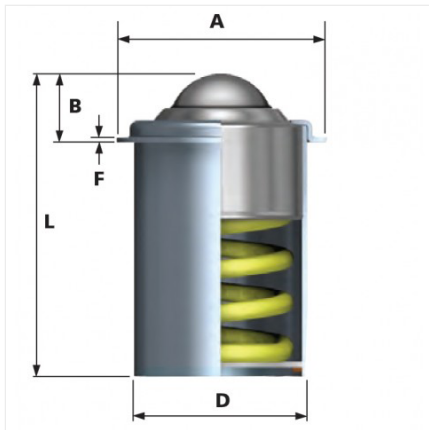

Especificaciones

Material	Acero galvanizado
Material del balín	Acero inoxidable
Diámetro	39.7 mm
Marca	Alwayse
Capacidad de carga	100 kg
Tipo de montaje	Brida
Peso	1.8 kg