

4007-13

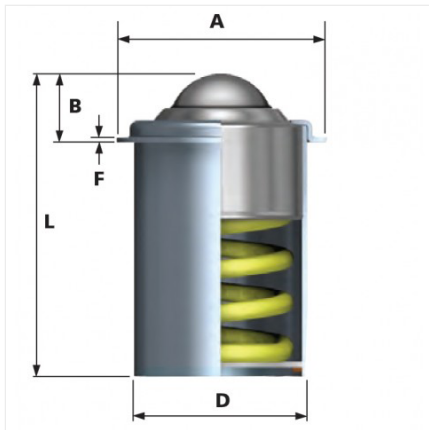

Especificaciones

Material	Acero galvanizado
Material del balín	Acero al carbón
Diámetro	50.8 mm
Marca	Alwayse
Capacidad de carga	170 kg
Tipo de montaje	Brida
Peso	4.4 kg