

545-2-15

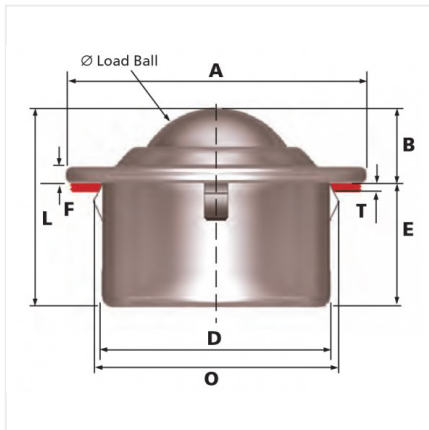

Especificaciones

Material	Acero inoxidable
Material del balín	Acero inoxidable
Diámetro	44.5 mm
Marca	Alwayse
Capacidad de carga	250 kg
Tipo de montaje	Inserto
Peso	0.725 kg