

545-2-16

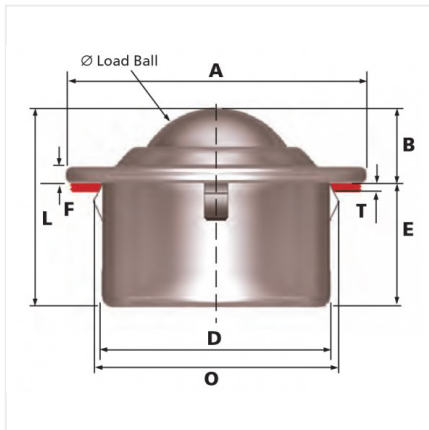

Especificaciones

Material	Acero galvanizado
Material del balín	Acero inoxidable
Diámetro	44.5 mm
Marca	Alwaysse
Capacidad de carga	610 kg
Tipo de montaje	Inserto
Peso	0.725 kg