

545-6-15

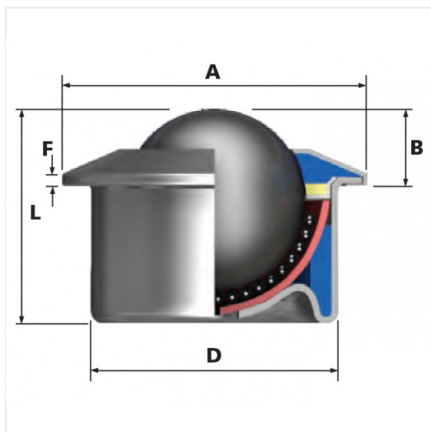

## Especificaciones

Material	Acero inoxidable
Material del balín	Acero inoxidable
Diámetro	44.5 mm
Marca	Alwaysse
Capacidad de carga	250 kg
Tipo de montaje	Inserto
Peso	0.887 kg