

1005-15

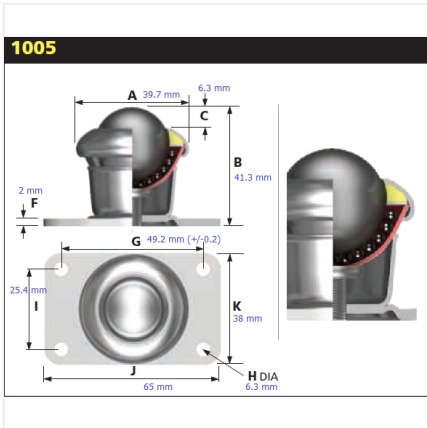

Especificaciones

Material	Acero inoxidable
Material del balín	Acero inoxidable
Diámetro	25.4 mm
Marca	Alwayse
Capacidad de carga	55 kg
Tipo de montaje	Placa
Peso	0.16 kg