

7124-13

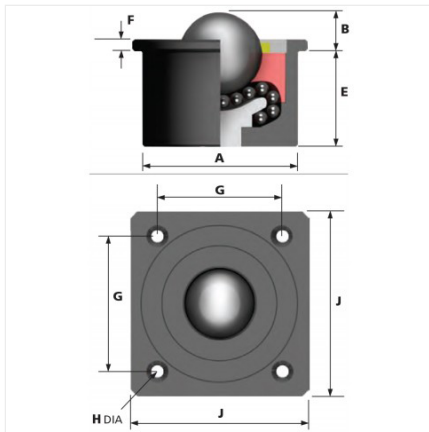

Especificaciones

Material	Acero galvanizado
Material del balín	Acero al carbón
Diámetro	25.4 mm
Marca	Alwayse
Capacidad de carga	135 kg
Tipo de montaje	Placa
Peso	0.463 kg