

1016-16

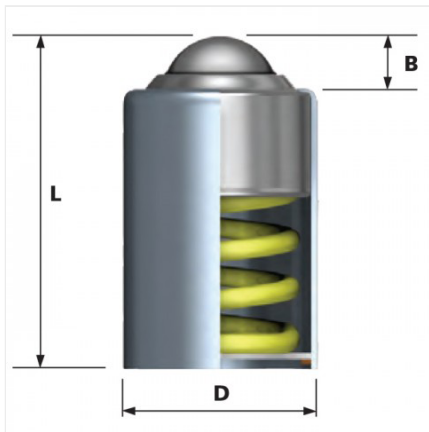

Especificaciones

| | |
|--------------------|-------------------|
| Material | Acero galvanizado |
| Material del balín | Acero inoxidable |
| Diámetro | 25.4 mm |
| Marca | Alwayse |
| Capacidad de carga | 35 kg |
| Tipo de montaje | Inserto |
| Peso | 0.38 kg |