

1019-23-15

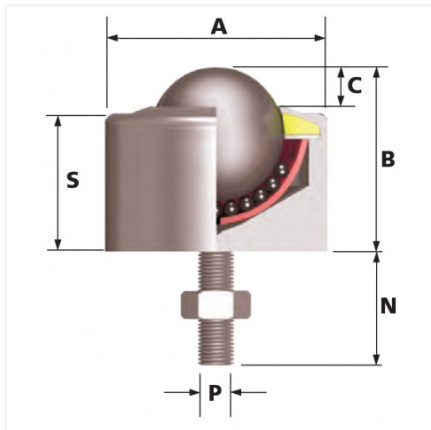

Especificaciones

Material	Acero inoxidable
Material del balín	Acero inoxidable
Diámetro	25.4 mm
Marca	Alwaysse
Capacidad de carga	125 kg
Tipo de montaje	Vástago
Peso	0.19 kg